

Case :	Existing Case 33.0(W)x41.0(H)mm
Dial Opening :	Ø28.0mm
Bracelet / Strap :	14.0x12.0mm
Crown :	Ø4.0mm
Water Resistant :	3ATM
Scale :	100%

Model No.: C3987ALX	Case Material: Alloy	Movement: 2035	Marketing: Ho
Brand Name: Carly Rex DENMARK	Design Ref. No.: CS2203118	Designer: Andrew	Date: 30/Mar/2022



Version-A



Version-B



Version-C

Case :	34.0(W)x42.0(H)mm
Dial Opening :	Ø26.5mm
Bracelet / Strap :	14.0x12.0mm
Crown :	Ø4.5mm
Water Resistant :	3ATM
Scale :	100%

Model No.: BD-2196S	Case Material: S.S	Movement: Miyota 6P29	Marketing:
Brand Name:	Design Ref. No.: BD-22001	Designer:	Date: 01/03/2022



Version A

Version B

Version C

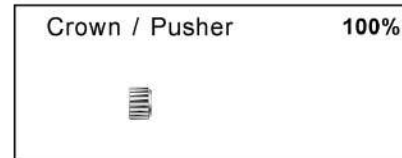
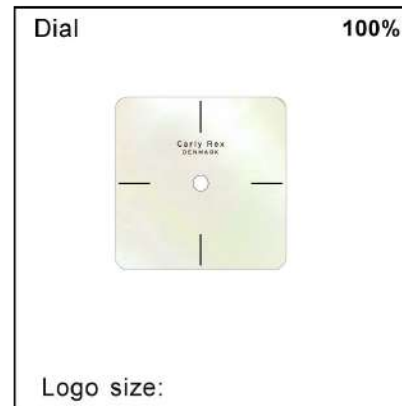
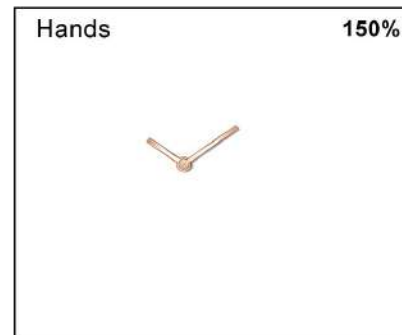

Case :	26.0(W)x26.0(H)mm
Dial Opening :	Ø23.2mm
Bracelet / Strap :	16.0-14mm
Crown :	Ø3.5mm
Water Resistant :	3ATM
Scale :	100%

Model No.:	PJ No.:	Movement: 2025	Marketing:
Brand Name:	Design Ref. No.: LA210360c	Designer:	Date: 23/FEB/2022

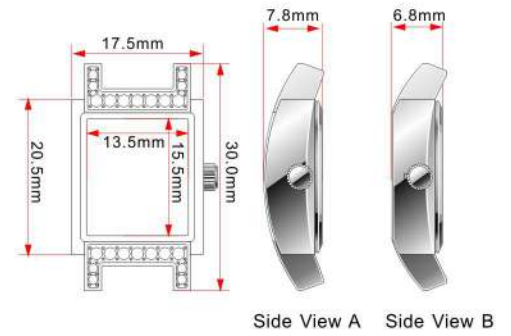

Case :	17.5(W)x30.0(H)mm
Dial Opening :	13.5(W)x15.5(H)mm
Bracelet / Strap :	14.0x14.0mm
Crown :	Ø3.5mm
Water Resistant :	3ATM
Scale :	100%

Model No.:	Case Material: Stainless steel	Movement: 5Y30	Marketing: Niki
Brand Name: Carly Rex DENMARK	Design Ref. No.: CS2112058B	Designer: Andrew	Date: 14/Jan/2022



A

B

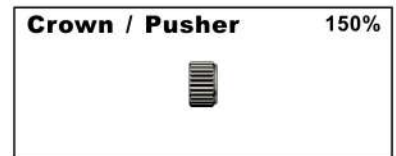
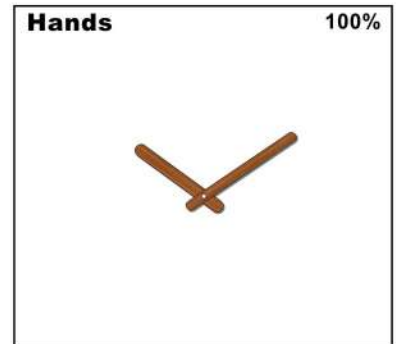

Case :	39.5(W)x39.5(H)mm
Dial Opening :	Ø34.0mm
Bracelet / Strap :	18.0x18.0mm
Crown :	Ø4.0mm
Water Resistant :	3ATM
Scale :	100%

Model No.:	Case Material: Stainless steel	Movement: 2025	Marketing: Ho
Brand Name: Carly Rex DENMARK	Design Ref. No.: CS2112059A	Designer: Tank	Date: 12/Jan/2022



C



D

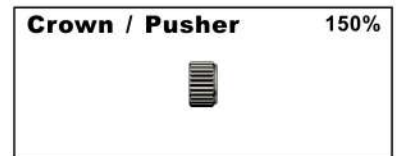
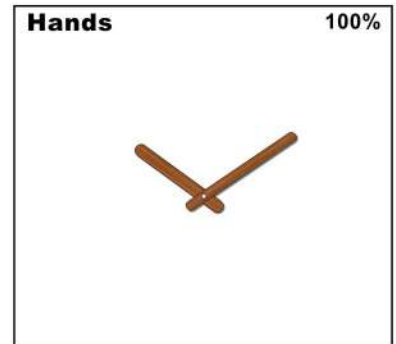

Case :	39.5(W)x39.5(H)mm
Dial Opening :	Ø34.0mm
Bracelet / Strap :	18.0x18.0mm
Crown :	Ø4.0mm
Water Resistant :	3ATM
Scale :	100%

Model No.:	Case Material: Stainless steel	Movement: 2025	Marketing: Ho
Brand Name: Carly Rex DENMARK	Design Ref. No.: CS2112059A	Designer: Tank	Date: 12/Jan/2022



Version D

Version E

Version F

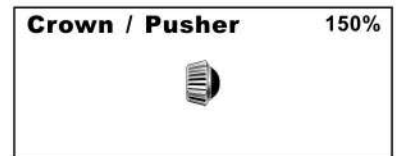

Case :	22.0(W)x36.5(H)mm
Dial Opening :	17.0(W)x24.0(H)mm
Bracelet / Strap :	12.0x10.0mm
Crown :	Ø4.0mm
Water Resistant :	3ATM
Scale :	100%

Model No.:	Case Material: Alloy	Movement: 2035	Marketing: Paul
Brand Name: Carly Rex DENMARK	Design Ref. No.: CS2111018B	Designer: Andrew	Date: 23/Nov/2021

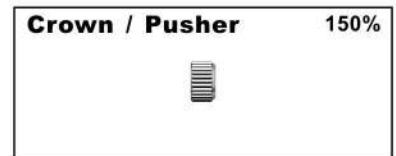

Case :	34.0(W)x38.5(H)mm
Dial Opening :	Ø19.0mm
Bracelet / Strap :	12.0x12.0mm
Crown :	Ø3.5mm
Water Resistant :	3ATM
Scale :	100%

Model No.:	Case Material: Alloy	Movement: PC20	Marketing: Ho
Brand Name: Carly Rex DENMARK	Design Ref. No.: CS2111044A	Designer: Andrew	Date: 22/Nov/2021



Version A

Version B

Version C

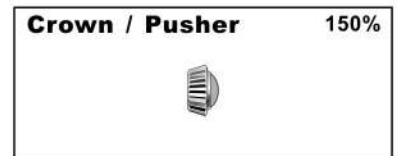
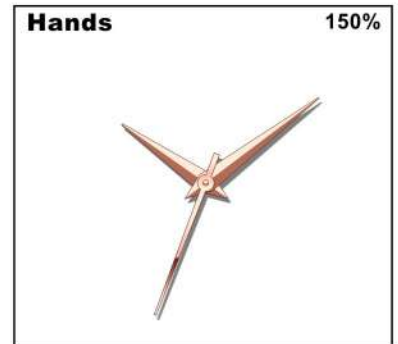

Case :	33.0(W)x38.0(H)mm
Dial Opening :	Ø27.0mm
Bracelet / Strap :	16.0x14.0mm
Crown :	Ø4.5mm
Water Resistant :	3ATM
Scale :	100%

Model No.:	Case Material: Alloy	Movement: PC21	Marketing: Paul
Brand Name: Carly Rex DENMARK	Design Ref. No.: CS2111054A	Designer: Tank	Date: 18/Nov/2021



Version A

Version B

Version C



Case :	30.6(W)x35.6(H)mm
Dial Opening :	Ø25.0mm
Bracelet / Strap :	14.0x14.0mm
Crown :	Ø3.0mm
Water Resistant :	3ATM
Scale :	100%

Model No.:	Case Material: Stainless steel	Movement: 2035	Marketing: Andy
Brand Name: Carly Rex DENMARK	Design Ref. No.: CS2111058A	Designer: Tank	Date: 22/Nov/2021



Version A

Version B

Version C



Case :	36.5(W)x43.0(H)mm
Dial Opening :	Ø30.0mm
Bracelet / Strap :	17.0x14.0mm
Crown :	Ø4.0mm
Water Resistant :	3ATM
Scale :	100%

Model No.:	Case Material: Stainless steel	Movement: 2035	Marketing: Andy
Brand Name: Carly Rex DENMARK	Design Ref. No.: CS2111060B	Designer: Andrew	Date: 23/Nov/2021



A



B



C

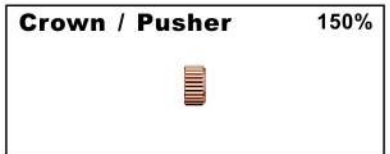

Case :	24.0(W)x30.0(H)mm
Dial Opening :	Ø19.0mm
Bracelet / Strap :	8.0x8.0mm
Crown :	Ø3.5mm
Water Resistant :	3ATM
Scale :	100%

Model No.:	Case Material: Alloy	Movement: PC21	Marketing: Paul
Brand Name: Carly Rex DENMARK	Design Ref. No.: CS2111017	Designer: Tank	Date: 05/Nov/2021



Version A

Version B

Version C



Case :	22.0(W)x36.5(H)mm
Dial Opening :	17.0(W)x24.0(H)mm
Bracelet / Strap :	12.0x10.0mm
Crown :	Ø4.0mm
Water Resistant :	3ATM
Scale :	100%

Model No.:	Case Material: Alloy	Movement: 2035	Marketing: Paul
Brand Name: Carly Rex DENMARK	Design Ref. No.: CS2111018A	Designer: Andrew	Date: 09/Nov/2021



Version A

Version B

Version C

Case :	23.5(W)x35.5(H)mm
Dial Opening :	18.0x22.5mm
Bracelet / Strap :	16.0x16.0mm
Crown :	Ø3.5mm
Water Resistant :	3ATM
Scale :	100%

Model No.: 2303S	Case Material: Stainless steel	Movement: VJ21	Marketing:
Brand Name: Carly Rex DENMARK	Design Ref. No.: BD-21022	Designer:	Date: 27/10/2021



Version D

Version E

Version F

Case :	23.5(W)x35.5(H)mm
Dial Opening :	18.0x22.5mm
Bracelet / Strap :	16.0x14.0mm
Crown :	Ø3.5mm
Water Resistant :	3ATM
Scale :	100%

Model No.: 2303S	Case Material: Stainless steel	Movement: VJ21	Marketing:
Brand Name: Carly Rex DENMARK	Design Ref. No.: BD-21022	Designer:	Date: 29/10/2021



Etching

C3559ALX-A

C3559ALX-B

C3559ALX-C

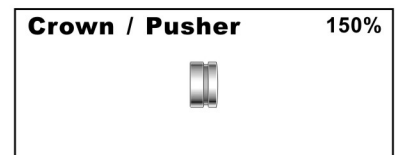
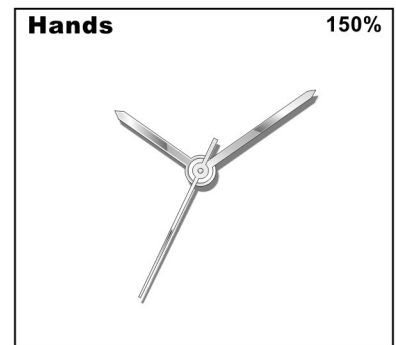

Case :	Existing Case 34.0(W)x34.0(H)mm
Dial Opening :	Ø31.0mm
Bracelet / Strap :	16.0x14.0mm
Crown :	Ø4.0mm
Water Resistant :	3ATM
Scale :	100%

Model No.: C3559ALX	Case Material: Alloy	Movement: PC21S	Marketing: Paul
Brand Name: Carly Rex DENMARK	Design Ref. No.: CS2108011D	Designer: Tank/Andrew	Date: 18/Aug/2021



Case :	36.0(W)x42.0(H)mm
Dial Opening :	Ø30.0mm
Bracelet / Strap :	14.0x14.0mm
Crown :	Ø3.5mm
Water Resistant :	3ATM
Scale :	100%

Model No.:	Case Material: Alloy	Movement: PC21	Marketing: Peggy
Brand Name: Carly Rex DENMARK	Design Ref. No.: CS2109066	Designer: Tank ★	Date: 16/Sep/2021

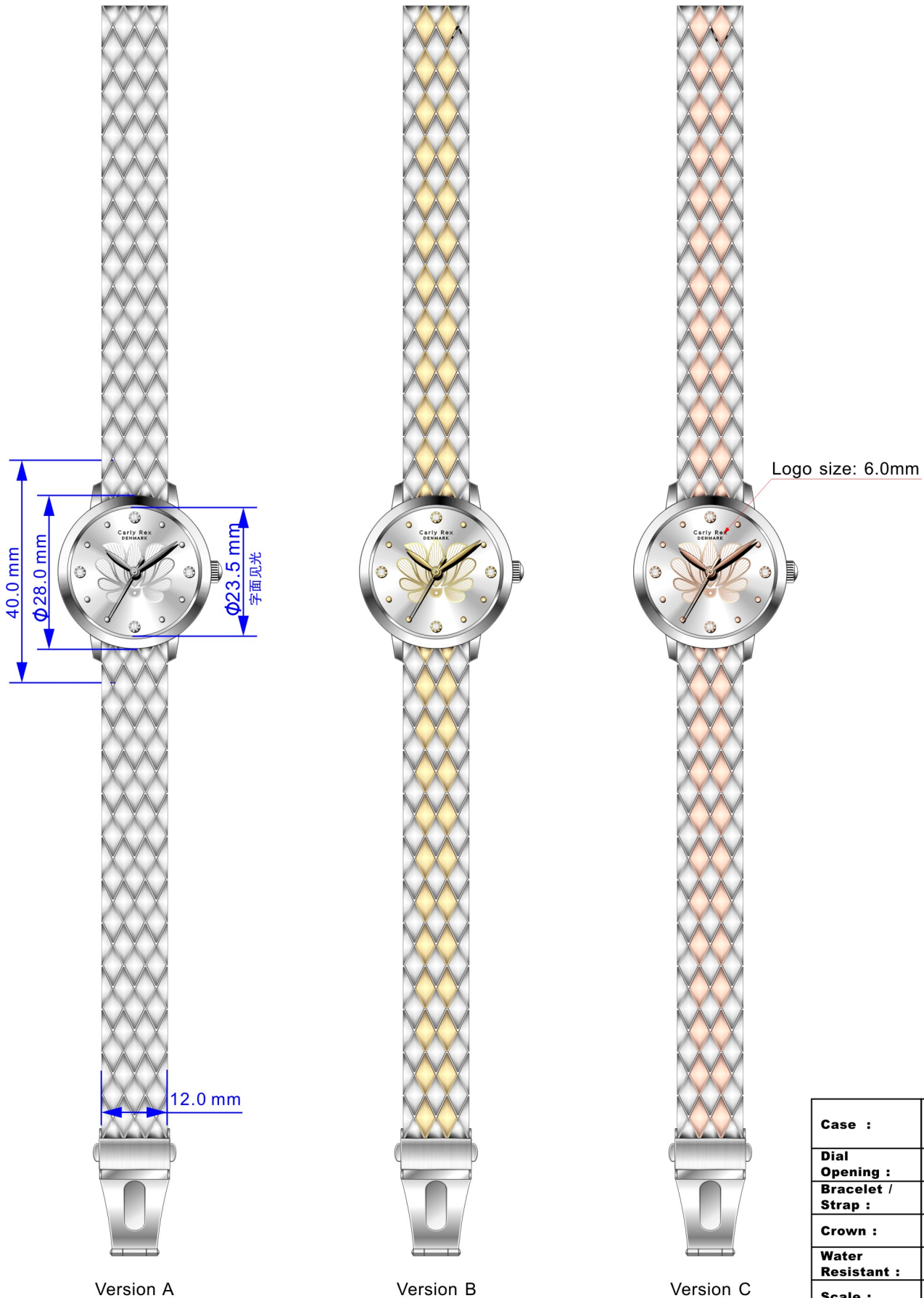

Case :	28.0(W)x33.0(H)mm
Dial Opening :	Ø23.5mm
Bracelet / Strap :	12.0x12.0mm
Crown :	Ø4.0mm
Water Resistant :	3ATM
Scale :	100%

Model No.:	Case Material: Alloy	Movement: PC21	Marketing: Peggy
Brand Name: Carly Rex DENMARK	Design Ref. No.: CS2109067	Designer: Tank ★	Date: 16/Sep/2021

STONE: 16 PCS



Version B



Version C

Case :	26.5(W)x32.0(H)mm
Dial Opening :	Ø22.0mm
Bracelet / Strap :	11.5x10.5mm
Crown :	Ø3.5mm
Water Resistant :	3ATM
Scale :	100%

Model No.:	Case Material: Alloy	Movement: PC21	Marketing: Peggy
Brand Name: Carly Rex DENMARK	Design Ref. No.: CS2109068	Designer: Tank ★	Date: 16/Sep/2021



Silver white

Sunray

White

Movable

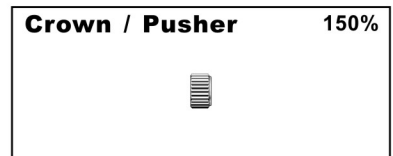

Case :	Ø28.0mm
Dial Opening :	Ø23.5mm
Bracelet / Strap :	32.0x32.0mm
Crown :	Ø3.0mm
Water Resistant :	3ATM
Scale :	100%

Version A

Version B

Version C

Model No.:	Case Material: Alloy	Movement: 2035	Marketing: Kristy
Brand Name: Carly Rex DENMARK	Design Ref. No.: CS2107023B	Designer: Tank	Date: 04/Aug/2021



C3015SLX-A

C3015SLX-B

C3015SLX-C

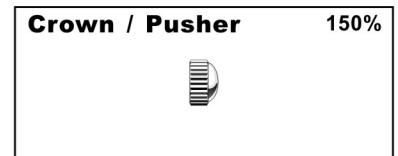
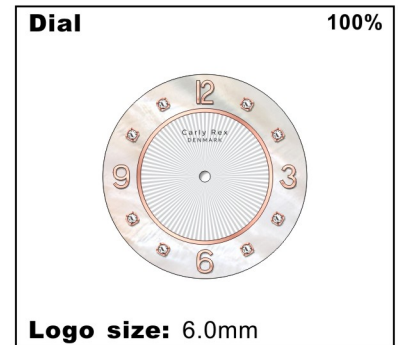
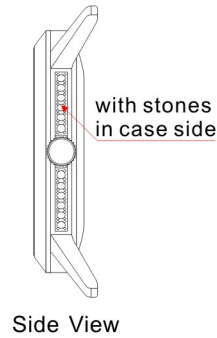

Case :	32.0(W)x38.5(H)mm
Dial Opening :	Ø27.0mm
Bracelet / Strap :	18.0x14.0mm
Crown :	Ø4.0mm
Water Resistant :	
Scale :	100%

Model No.: C3015SLX	Case Material: Stainless steel	Movement: Y121	Marketing: Niki
Brand Name: Carly Rex DENMARK	Design Ref. No.: CS2107030A	Designer: Tank	Date: 02/Aug/2021